

WALL MOUNTING DETAIL

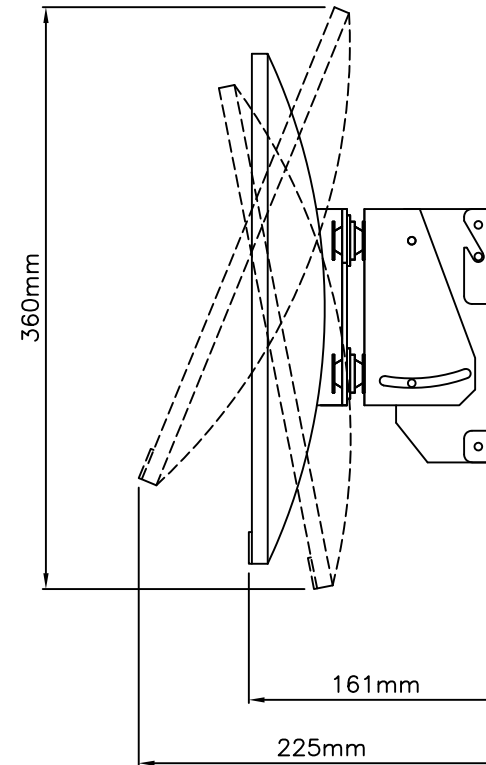

NOTES: 1) WALL MOUNTING OPTIONS (CUSTOMER PROVIDED):

- a) M5 TAPPED HOLES IN BULKHEAD
 - b) M5 STUDS IN BULKHEAD
- 2) ALLOW 10mm CLEARANCE ON OVERALL DIMENSIONS FOR VIBRATION & VENTILATION
- 3) ANTI-VIBRATION MOUNT DETAIL: STOP-CHOC M2K22-00181 (4 OFF)
- 4) MONITOR TILT RANGE -10 / +20 DEGREES

MARINER
SYSTEMS
(UK) LTD

USED IN CONJUNCTION WITH:
HP E24 G5 FHD 23.8" Monitor
(WALL MOUNT)

DRAWING TITLE: MS1735 ASSEMBLY

SCALE: DRAWN 1:1
ISSUE: 1

DWG NO: MS1735_A
DATE: 26 SEP 2023